



University of
Salford
MANCHESTER

Gas lift optimization to improve well performance

Abdalsadig, MA, Nourian, A, Nasr, GG and Babaie, M

Title	Gas lift optimization to improve well performance
Authors	Abdalsadig, MA, Nourian, A, Nasr, GG and Babaie, M
Type	Article
URL	This version is available at: http://usir.salford.ac.uk/id/eprint/38144/
Published Date	2016

USIR is a digital collection of the research output of the University of Salford. Where copyright permits, full text material held in the repository is made freely available online and can be read, downloaded and copied for non-commercial private study or research purposes. Please check the manuscript for any further copyright restrictions.

For more information, including our policy and submission procedure, please contact the Repository Team at: usir@salford.ac.uk.

Gas Lift Optimization to Improve Well Performance

Mohamed A. G. H. Abdalsadig, Amir Nourian, G. G. Nasr, Meisam Babaie

Abstract—Gas lift optimization is becoming more important now a day in petroleum industry. A proper lift optimization can reduce the operating cost, increase the net present value (NPV) and maximize the recovery from the asset. A widely accepted definition of gas lift optimization is to obtain the maximum output under specified operating conditions. In addition, gas lift, a costly and indispensable means to recover oil from high depth reservoir entails solving the gas lift optimization problems. Gas lift optimization is a continuous process; there are two levels of production optimization. The total field optimization involves optimizing the surface facilities and the injection rate that can be achieved by standard tools softwares. Well level optimization can be achieved by optimizing the well parameters such as point of injection, injection rate, and injection pressure. All these aspects have been investigated and presented in this study by using experimental data and PROSPER simulation program. The results show that the well head pressure has a large influence on the gas lift performance and also proved that smart gas lift valve can be used to improve gas lift performance by controlling gas injection from down hole. Obtaining the optimum gas injection rate is important because excessive gas injection reduces production rate and consequently increases the operation cost.

Keywords—Optimization, production rate, reservoir pressure effect, gas injection rate effect, gas injection pressure.

I. INTRODUCTION

OIL production from depleted reservoirs with insufficient energy often requires an artificial method to lift fluids from the bottom hole to the surface. Sucker rod pump, electric submersible pump and gas lift are the most common artificial lift methods used to lowering the bottom hole pressure and providing the lift energy to raise the fluids to the surface.

In gas lift methods, a compressed gas is injected at high pressure in the annulus which lightens the fluid column by reducing its density and pressure losses. The presence of gas inside the production tubing at the deepest point reduces the flow pressure of the bottom-hole to allow fluid to flow from reservoir to the surface [1].

Redden et al. calculated optimum distribution of available lift gas for a group of gas lifted wells based on each well's contribution to the profit of the system [2]. Kanu presented the formulation of an economic slope based on the concept that the profit from incremental recovery of oil should be equal to the cost of additional gas injected [3]. Coltharp and Khokhar devolved a computer gas lift surveillance and gas injection control system installed in Dubai [4].

Edwards established a gas-lift optimization and production allocation model for manifold subsea wells [5]. Lemetayer and Miret used programmable logic controller to increase the gas-lift efficiency with an increase in oil production and a decrease in gas injection [6]. Osuji viewed the advances in the gas-lift system since 1846 [7]. Everitt showed that the gas-lift optimization efforts in a large mature field could reduce the gas-lift requirements by 50% [8]. Buitrago et al. used a global optimization technique for determining the optimum gas injection rate for a group of wells in order to maximize the total oil production rate for a given total amount of gas without restriction in the well response and the number of wells in the system [9].

Handley-Schachler et al. determined the optimal lift-gas allocation to networks of gas-lifted wells [10]. Ghoniem, et al described the construction of using general optimization allocation models for Khafji field in the Arabian Gulf [11]. Rashidi et al. presented the gas-lift optimization problems [12]. Sylvester presented a sensitivity analysis for production optimization [13].

II. THE PROBLEM DEFINITION

The goal of gas-lift is to deliver the fluid to the top of the well head while keeping the bottom-hole pressure low enough to provide high pressure drop between the reservoir and bottom hole. Reduction of bottom hole pressure due to gas injection will normally increase liquid production rate. However, injecting too much amount of gas will increase the bottom hole pressure which will lead to the decline of the production flow rate.

Operating a gas-lift under low or high gas-lift injection rate has some disadvantage. First, the full lift potential in the gas is not accurately used, resulting in a very inefficient operation. Secondly, pressure surges in production facilities may be so huge that severe operational problems are likely to happen. Moreover, production control becomes very difficult. Well performance analysis is a combination of various components of oil or gas wells in order to predict flow rates and to optimize the various components in the system. A variety of issues can impact the performance of gas-lift wells. These issues are frequently classified as either inlet/outlet issue or down hole issue [14].

Inlet issues are the conditions which inhibit or obstruct the injection of gas into the well. Outlet issues are the conditions where downstream of the well head impairs a well's ability to flow. Such items include: excessive back pressure due to production choke, under sized flow line or manifolds and high separator pressure.

Down hole issues which include the events occurring below the well head impair the well's production performance,

change of the reservoir fluid conditions, injection rate, and valve port size [15]. Efficient gas-lift design requires deep knowledge about the performance of each component of the gas-lift system and theoretical analysis supported by experiments.

III. THE AIM AND OBJECTIVES

The aim and objectives of every business always culminate in maximizing profitability in safe and economic ways. The aim of this study is to address the effects of some of the well operating parameters on production flow rates in the gas-lift wells. To investigate the following:

- i. The effect of reservoir pressure on productivity.
- ii. Estimate the production operation point.
- iii. The effect of injection gas rate.
- iv. Injection rate effect on well head pressure.
- v. The effect gas injection pressure on well performance.

IV. METHODOLOGY

Experiment Description: In order to facilitate the emulation of a real-world well, the following main components are presented. Realistic tests for gas-lift wells are performed using gas-lift well Laboratory equipment's as it is shown in Fig. 1.

Experiment Equipment's: Plastic storage tank (1), Centrifugal pump (2), Hand valve (3), By pass line (4), Inflow digital meter (5), Check valve (6), Transparent tubing (7), Electric gas-lift (8), Tubing pressure Gauge (9), Out flow digital meter (10), Flow line (11), Gas compressor (12), Gas flow meter (13), Gas regulator (14), Gas-lift line (15), Control line (16), Monitor system (17).

Fig. 1 shows the laboratory installation for gas-lift well, using compressor air as gas-lift and water as production fluid. The production tube is PVC transparent to facilitate visual inspection of the flow regimes and changes at different locations. The length of the tube is 2 meters in height with an inner diameter of 66 mm, outer diameter 76 mm, and pipe thickness 5 mm. A pump is used to deliver high pressure water from plastic tank to the certain level into the transparent tube. The pump can be operated with a variable speed to produce proper pressure (referred to reservoir pressure) and also can be controlled by using a manual valve in the discharge of the pump. When the pump pressure is not able to deliver the fluid to the surface, gas-lift technique will be applied by injecting air into the tubing. Electric valve is used to inject air inside the

tubing. The valve is connected to control line to provide real opening or closing and can be operated with variable opening flow rate by the use of computer program. Air flow rate that fed into the tubing can be controlled at different flow rate and different injection pressure by using air injection regulator and air flow meter. As soon as the air is injected into the tubing, the fluid hydrostatic pressure and the density of the production fluid reduce and the fluid will be delivered out of the tubing. Inflow and outflow are measured by two digital flow meters and pressure gauges are also installed to monitor the inlet and out let pressure.

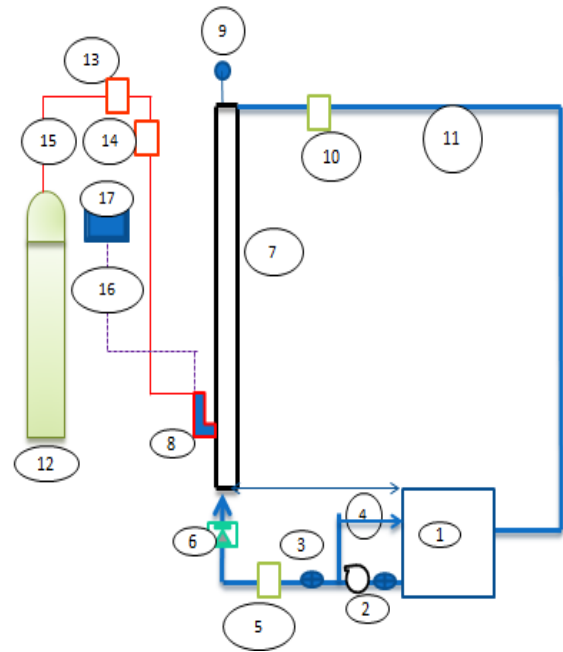

Fig. 1 The experiment flow diagram

V. WELL MODEL CONSTRUCTION

The system has been modeled by using PROSPER software [16]. Actual experimental data were entered to the model. Input data including the deviation survey, down hole completion, geothermal gradient, and the gas-lift data were used for the assumed wells. First the down hole equipment and inflow were modeled, and then the existing gas-lift designs were studied. Figs. 2 and 3 illustrated the model in software.

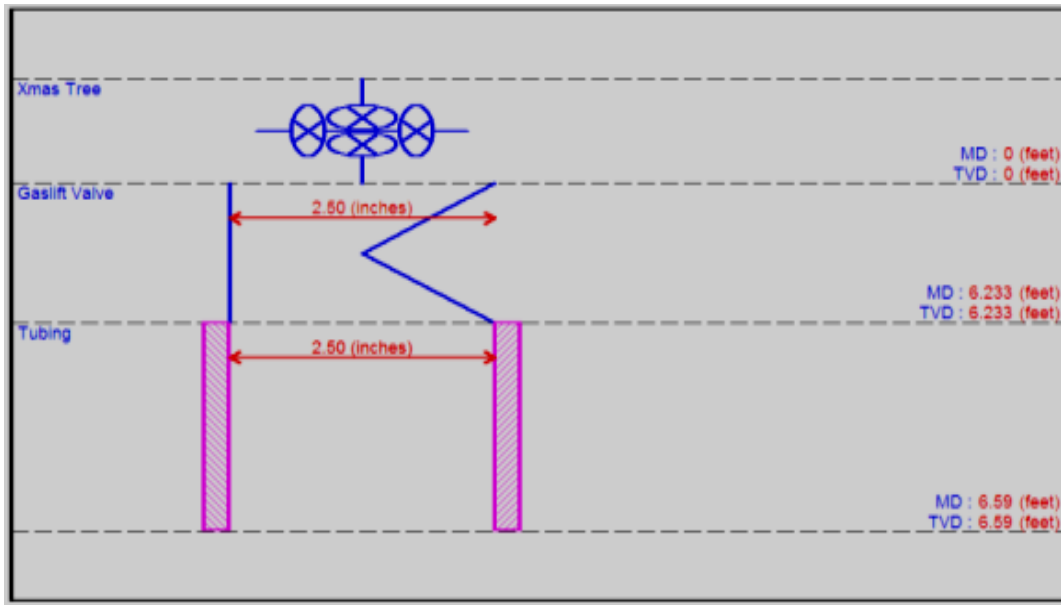

Fig. 2 Well Completion from PROSPER

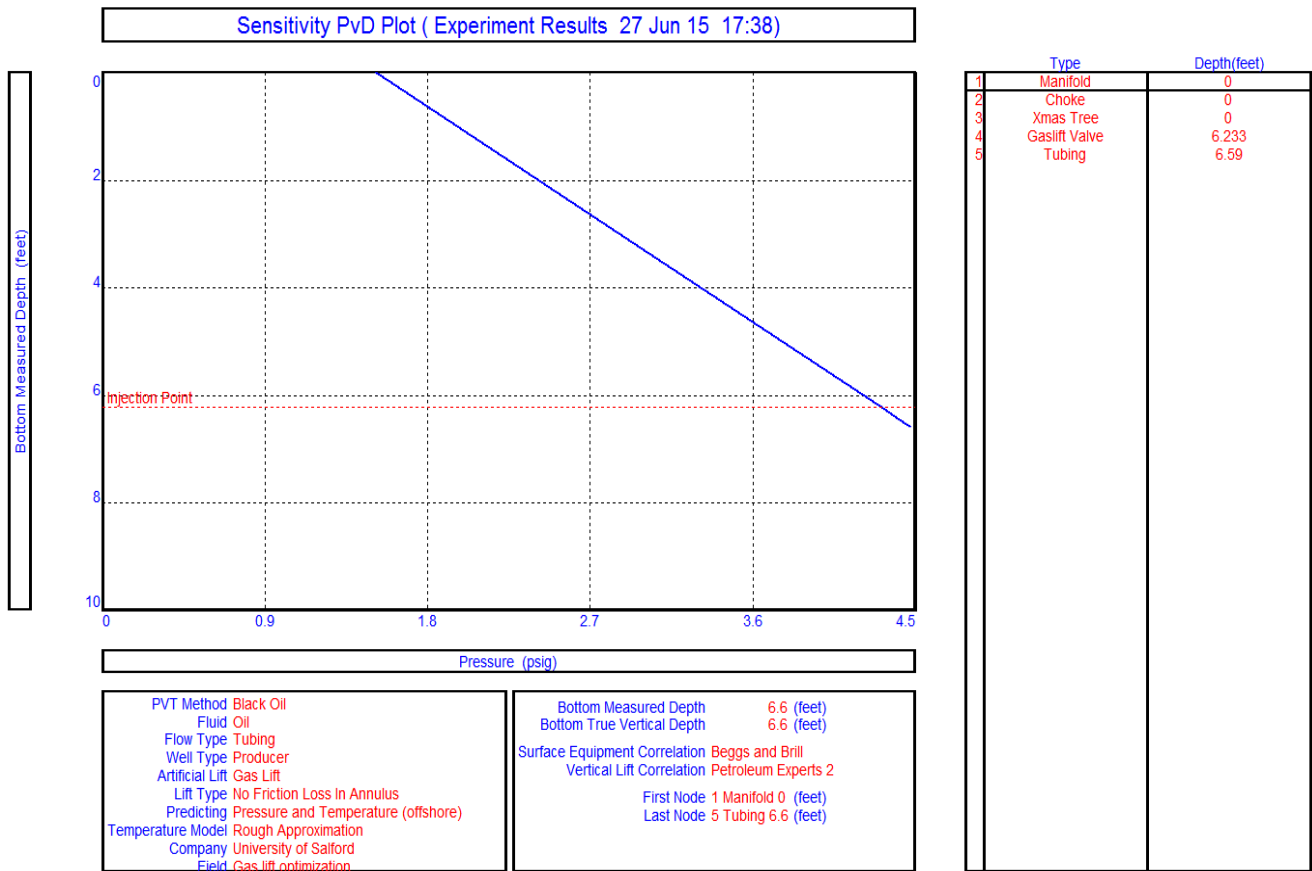

Fig. 3 The injection point located at the bottom of the production tube

VI. RESULTS

A. Reservoir Pressure Effect

Through the reservoir production life reservoir pressure will decline. Likewise, after water breakthrough the fluid column weight will increase as hydrostatic pressure will rise because of the increased water and oil mixture density. In this

situation, reservoir pressure may not be sufficient to lift up the fluid from the bottom to the surface. Several techniques must be applied to avoid the production decline. In this case, artificial lift techniques are applied to add energy to the produced fluids.

Fig. 4 illustrates that changing the reservoir pressure leads to change in liquid production rate. Reservoir sensitivity analysis was carried out and the result is presented in Fig. 5. It is clearly shown that the economic reservoir pressure is 4 psi.

B. Operating Point

To calculate the well production rate, the bottom-hole pressure which simultaneously satisfies both the IPR and VLP relations is required. By plotting the IPR and VLP in the same graph, the production rate can be found. The system can be described by an energy balance expression, simply the principle of conservation of energy over an incremental length element of tubing. The energy entering the system by the flowing fluid must be equal to the energy leaving the system plus the energy exchanged between the fluid and its surroundings. Fig. 6 illustrates that performance of the corresponding well is satisfactory at pressure 4 psig and production rate 132 bbl. / day.

C. Injection Rate Effect

The amount of gas available for the injection process is very important for the production performance of the field. If limited gas is available for injection, the gas must be allocated properly to each well in the field in order to maximize the total field oil rate and enhance the gas-lift wells performance.

In this section, different gas injection rates were applied in different wells that were producing by gas-lift flow with different flow rates as shown in Fig. 7, to investigate the effect of gas injection rate on production flow rate and how gas-lift technique can be used to improve production rate.

TABLE I
THE EFFECT OF INJECTION ARE ON LIQUID PRODUCTION FOR THREE ASSUMED RATES (10, 15 AND 20 L/MIN)

Air injection l/min	Well A	Well B	Well C
	Production Rate l/m	Production Rate l/m	Production rate l/m
0	10	15	20
2	14	20	25
4	15.5	23	28
6	13.3	21.5	26

Table I shows the comparison of air injection rate and liquid rates production for three assumed wells before and after lift optimization. The lift performance curves are plotted as the liquid rate of the well versus the gas injection rate for a given air injection pressure and shows the producing system response to continuous flow air lifting.

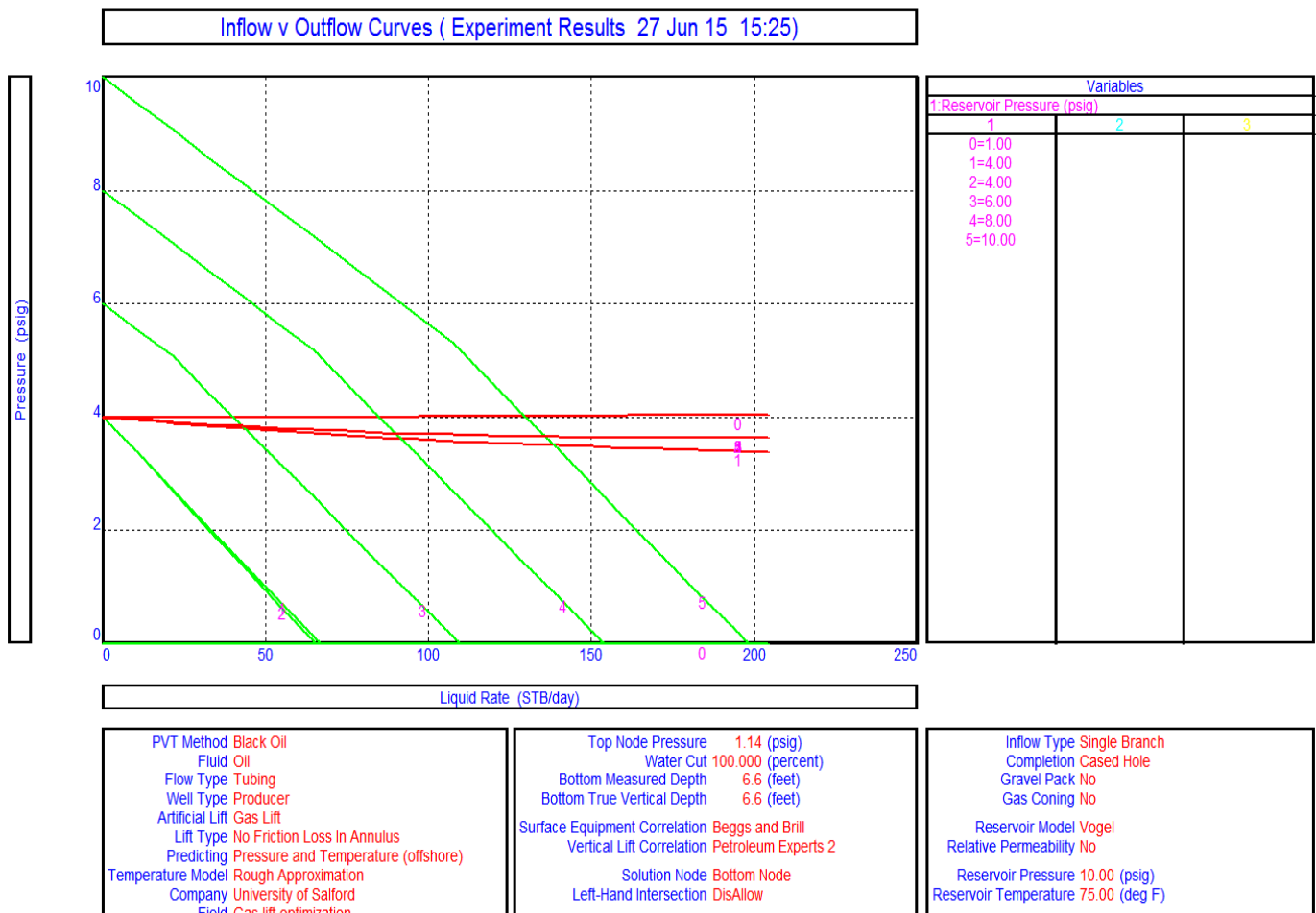

Fig. 4 The effect of reservoir pressure on liquid flow rates

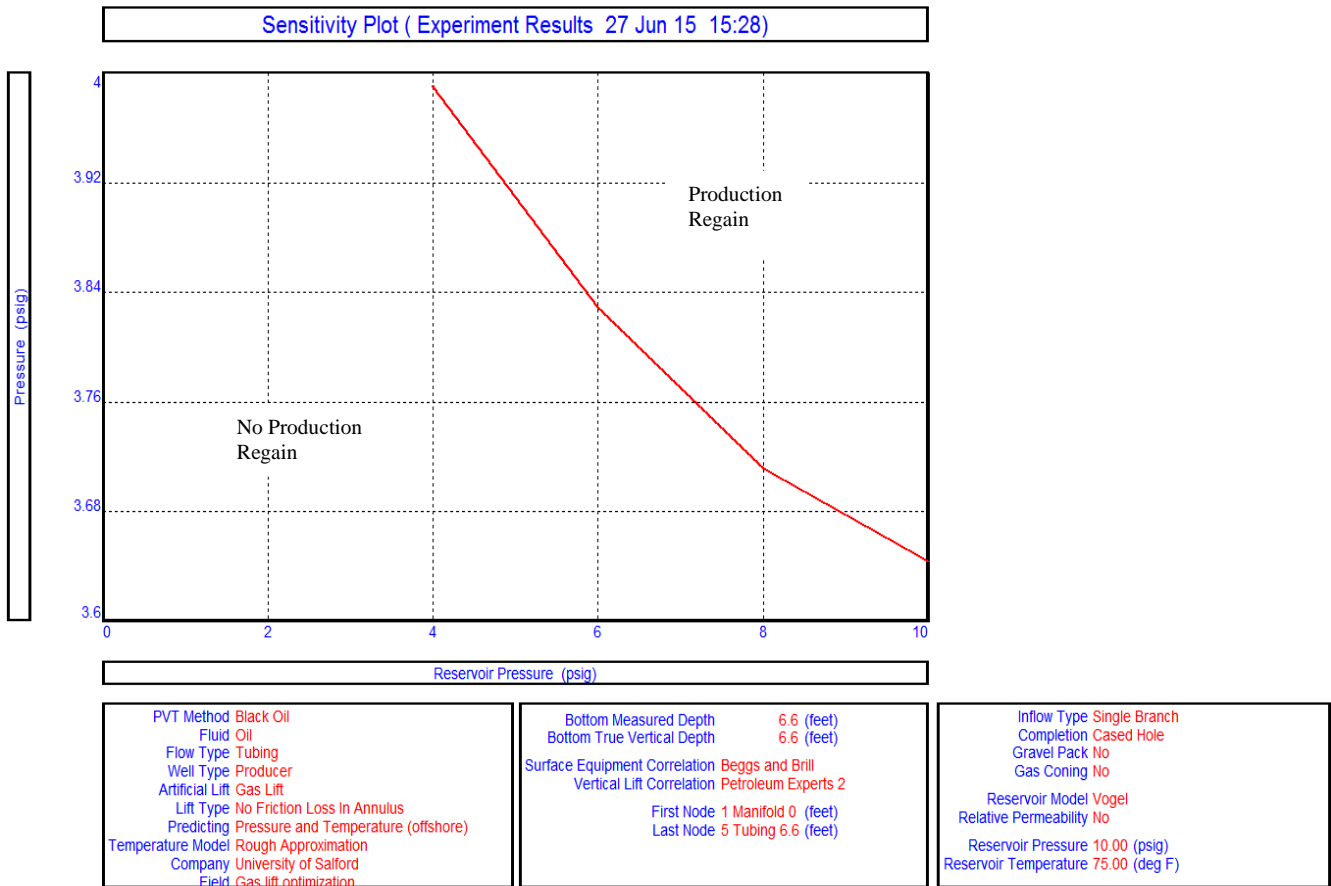

Fig. 5 The reservoir sensitivity analysis

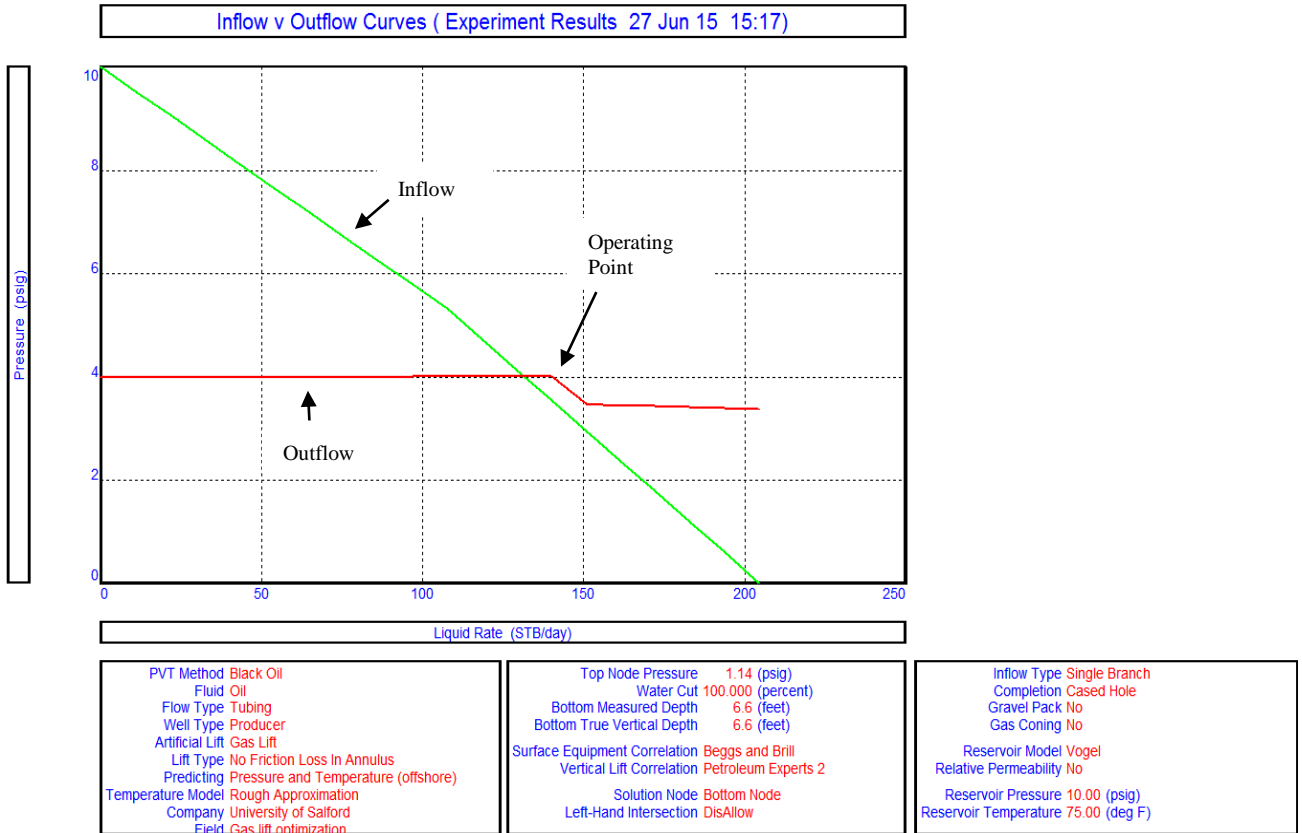

Fig. 6 Inflow and out flow relationship

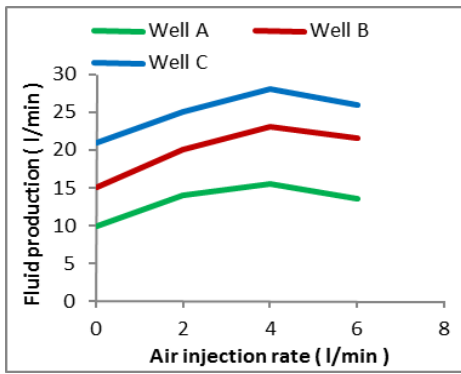

Fig. 7 Improve well performance

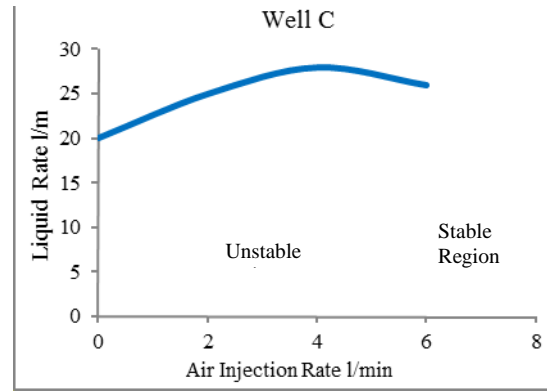

Fig. 10 Effect of injection rate on well performance

The results showed that the gas lift utilization can improve the productivity of producers. Figs. 8-10 show that at low injection rate, any increase in the air volume increases the well's liquid output. As injection rates raise, the rate of liquid volume increase falls off and the maximum possible liquid rate will be reached. After this maximum value, any additional gas injection reduces the liquid production and remains stable. From air optimization curves, it is clearly found that the optimum injected air is to get maximum liquid flow rate 4 l/min for different flow rates.

D. Effect on Wellhead Pressure

An increase in the wellhead pressure ordinarily results in a disproportionate increase at the bottom hole pressure because the higher pressure in the tubing causes a more liquid-like fluid. In order to get the adequate injection air pressure that enters to the experimental system, air pressure regulator with range 0-11 psig was installed, and the supplied air was measured by air flow meter. Smart gas-lift valve was employed to control the air flow rate inside the transplant tube by opening the valve with different port size based on computer program. The results indicate that injecting high amount of gas leads to the increase in well head pressure which decreases the production rate. It is obvious that the well head pressure has a large influence on the gas-lift performance while it was shown that by using electric controlled valve the production rate can be maximized. Figs. 11-13 and Table II show the effect of injection pressure on well head pressure for three assumed wells. It is seen that the wellhead pressure has a large influence on the gas-lift performance, as lower wellhead pressure leads to lower bottom hole pressure required for a given production flow rate. However, raise wellhead tubing pressure due to high pressure gas let's to reduce production rate. The results indicate that increase injection pressure from 29 psig to 58 psig leads to raise the wellhead pressure for all assumed well.

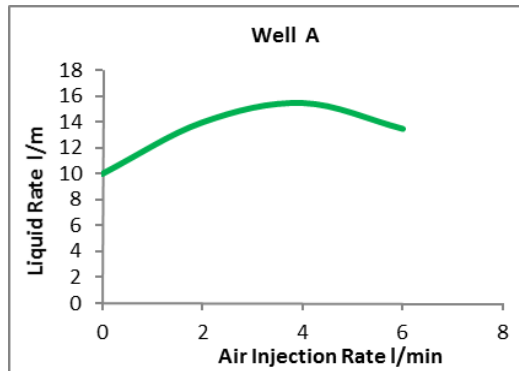

Fig. 8 The effect of injection rate on well performance at constant flow rate 10 L/min

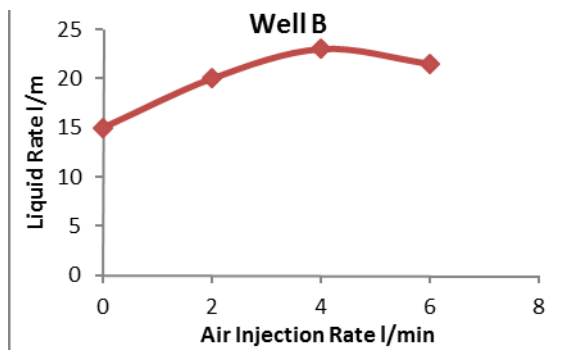

Fig. 9 Effect of injection rate on well performance at Constant flowrate 15

TABLE II
THE EFFECT OF INJECTION PRESSURE ON TUBING WELL HEAD PRESSURE

Air injection Pressure psig	Well 1	Well 2	Well3
	W.H.P psig	W.H.P psig	W.H.P psig
29	1	1.4	1.5
58	1.18	1.592	1.7
87	1.215	1.623	1.8

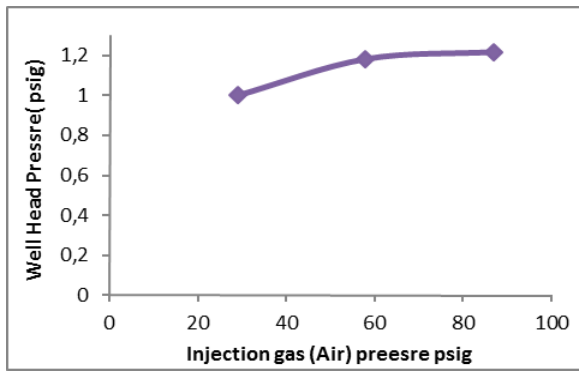

Fig. 11 The effect of injection pressure on well head pressure on well number A

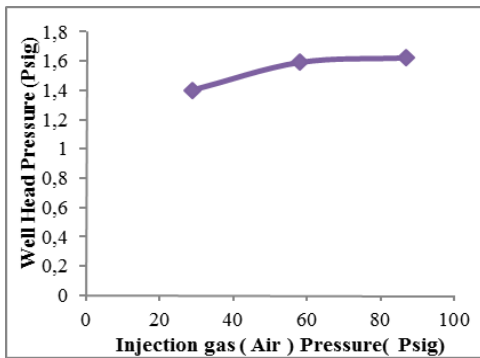

Fig. 12 The effect of injection pressure on wellhead pressure on well number B

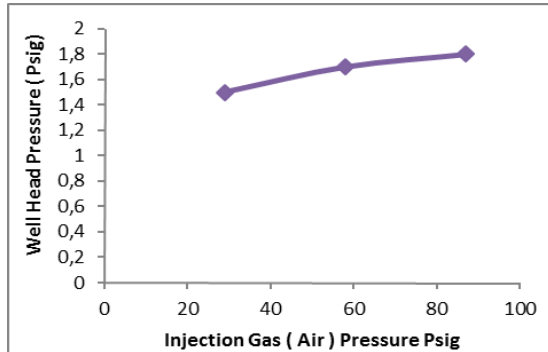

Fig. 13 The effect of injection pressure on well head pressure on well number C

In order to investigate the effect of injection pressure on well head tubing pressure, three different wells with different flow rates 10, 15 and 20 l/min and different injection pressure 29, 58 and 87 psig are modelled in PROSPER Software and the results are presented in Fig. 14 and Table III.

Economic sensitivity analysis has been carried out to find the optimum well head pressure, and the results indicated that high injection operating pressure leads to stop liquid flowing, as shown in Fig. 15.

TABLE III
THE WELL HEAD PRESSURE ON PRODUCTION FLOW RATE

S/N	Well Head Pressure (psia)	Liquid Flow Rate (stb/day)
1	0.5	134
2	1.0	132
3	1.5	122
4	2.0	113
5	3.0	93
6	4.0	71
7	6.0	26
8	8.0	0
9	10.0	0

E. Injection Pressure Effect on Production

Gas-lift pressure is a critical design parameter in the gas-lift system design. It has a major impact on completion design number of valves, well performance injection depth, system operating pressure compressor discharge, and obviously maternal and equipment specification all of which will have a significant impact on costs. Selection of a gas-lift pressure that is too high can result in needless investment in compression and other equipment, whereas pressures that are too low can cause loss of production potential and production deferment. To study the effect of injection pressure three different pressures 29, 58 and 87 psig were applied and potted versus. Outlet production and the results were as in Fig. 16. As shown in Fig. 16, it is clearly remarkable that increase the injection pressure from 58 psi to 87, psig provides slightly enhancement in flow rate while the production remains almost constant. This is because very high gas injection causes slippage, where gas phase moves faster than liquid phase, leaving the liquid phase behind. In this condition tubing pressure should be optimized with respect to the amount of gas injection rate.

VII. CONCLUSION

1. The gas injection rate must be controlled to achieve and maintain the critical flow. To determine the amount of gas to inject, it is necessary to find the critical velocity. Therefore, enough gas should be injected to keep the velocity above the critical level. In this study smart gas-lift valve was used to control gas injection rate by opening the valve with different percentage using computer program.
2. The results indicated that injecting high amount of gas increases the bottom hole pressure which lead to reduction of the production rate. This is due to the high gas injection rate which causes slippage. In this case gas phase moves faster than liquid phase, leaving the liquid phase behind and less amount of liquid will flow along the tubing. Hence, there should be an optimum gas injection rate.

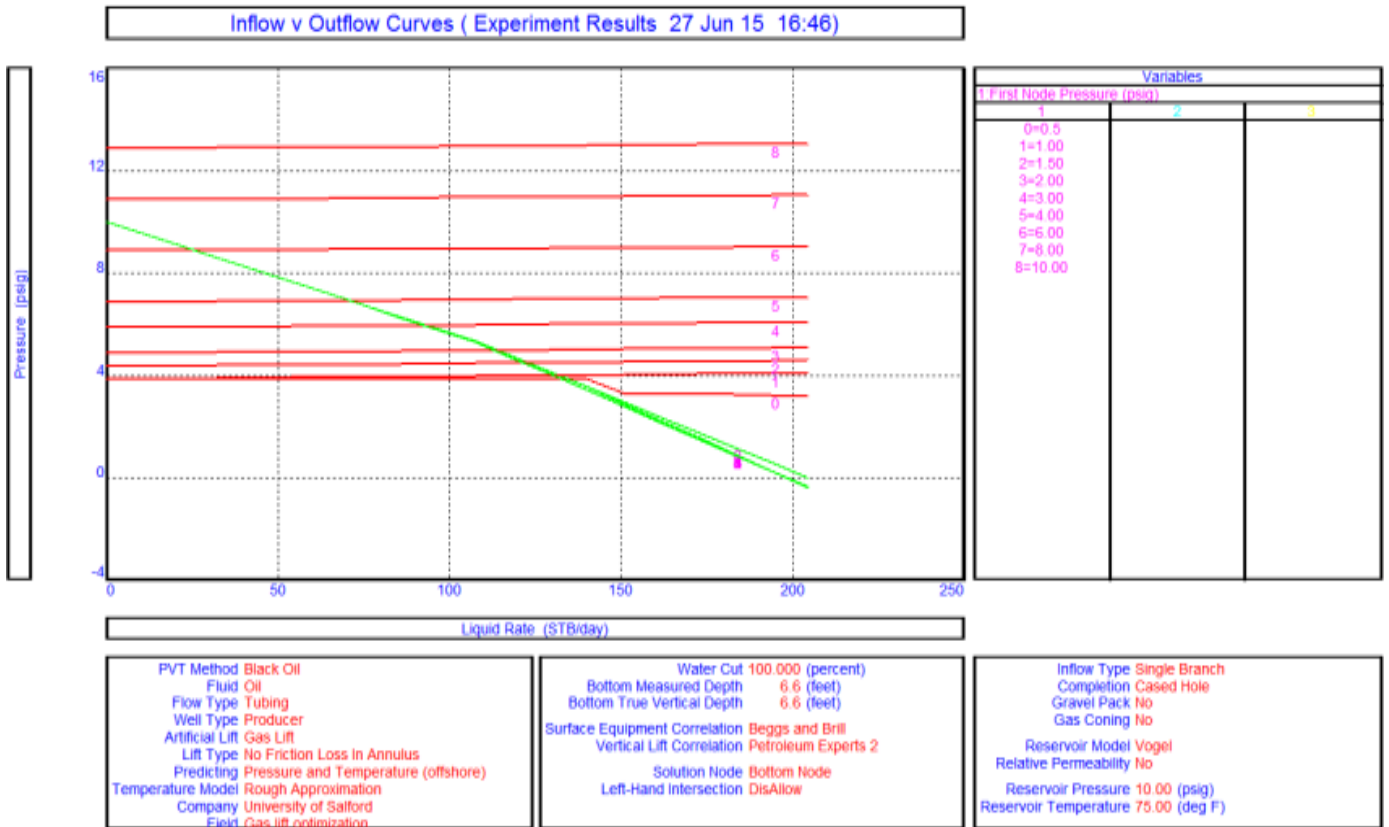

Fig. 14 The well head pressure on Production flow rate

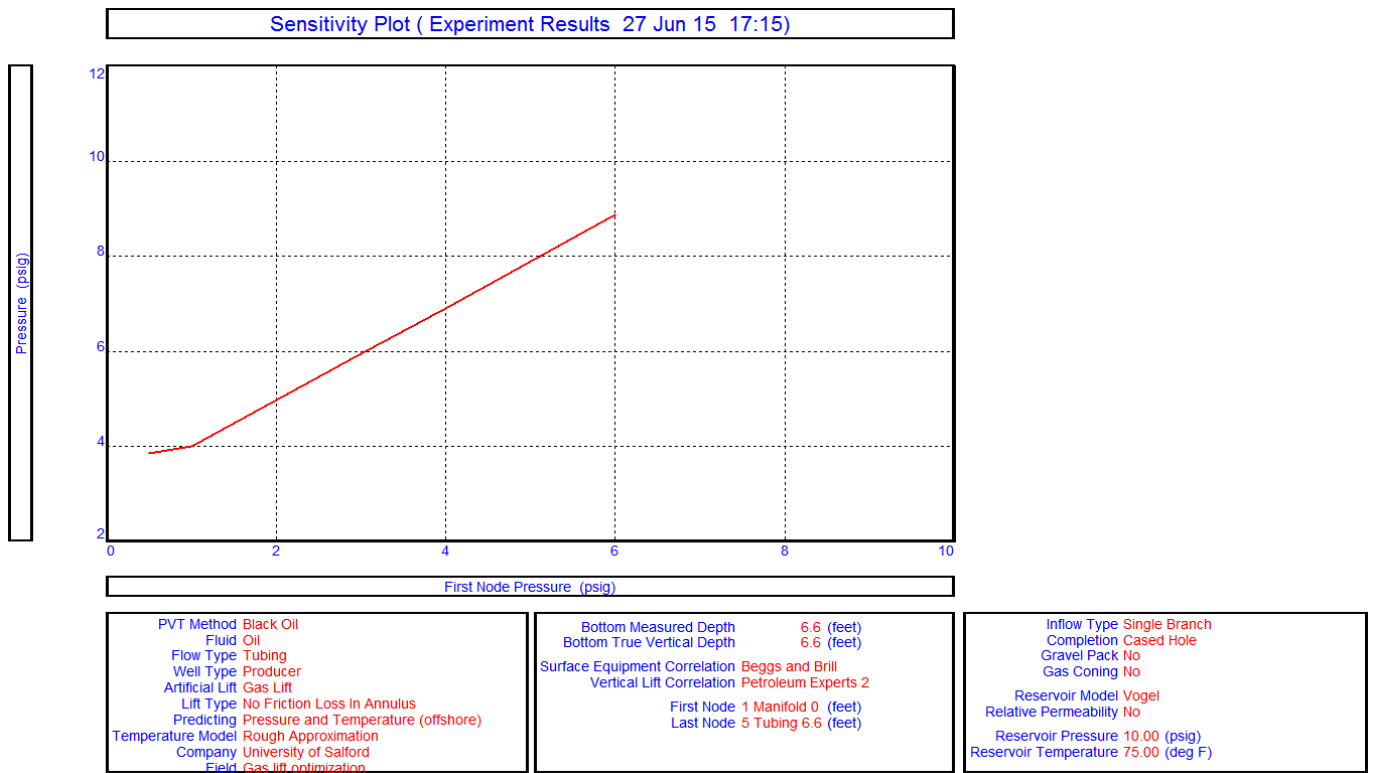

Fig.15 Economic well head pressure

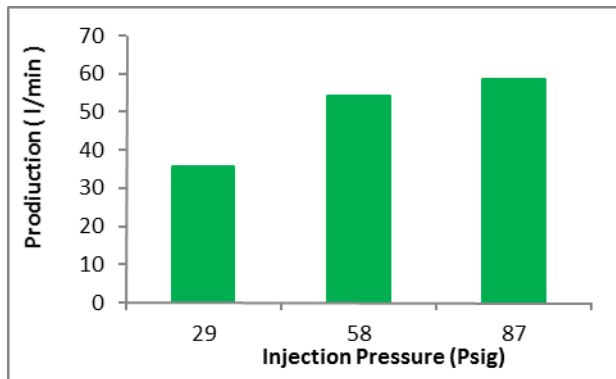

Fig. 16 The effect of injection pressure on production rate

3. It is demonstrated that the well head pressure has a large influence on the gas-lift performance and it is shown that the use of an electric control valve can help to improve gas-lift performance.
4. The optimization system also can assist engineers to observe live data from the field, therefore, then, the engineers can understand how to improve well performances in the field.
5. Production through gas-lifting does not only depend on injection rate, but also can be optimized through the completion design and monitoring the gas-lift supply pressure, total gas available, and other variables. Accordingly, the gas injection rate can be adjusted to yield maximum production rates.
6. An operating valve or orifice that has a large port may pass too much gas, thus creating instability or casing pressure heading. Over injection may be required to maintain stable operation.
7. The gas-lift system designer must be able to predict how far each valve will open under each condition of upstream and downstream pressure, and how much gas it will transmit under each condition.

REFERENCES

- [1] E. and P. D. American Petroleum Institute, "Gas Lift Book 6 of the," Dallas, 1994.
- [2] J. D. Redden, T. A. G. Sherman, and J. R. Blanns, "Optimizing Systems," 1974.
- [3] E. Kanu, J. Mach, and K. Brown, "Economic Approach to Oil Production and Gas Allocation in Continuous Gas Lift (includes associated papers 10858 and 10865)," *J. Pet. Technol.*, vol. 33, no. 10, 1981.
- [4] E. D. Coltharp and M. Khokhar, "Dubai Gas Lift Automation," *SPE 13203*, 1984.
- [5] R. Edwards, D. L. Marshall, and K. C. Wade, "A Gas-Lift Optimization and Allocation Model for Manifoldded Subsea Wells," *SPE*, 20979, no. Table 1, pp. 535-545, 1990.
- [6] P. Lemetayer and P. M. Miret, "Tool of the 90's To Optimize Gas-Lift Efficiency in the Gonelle Field, Gabon," *Offshore Eur.*, pp. 513-520, 1991.
- [7] L. C. Osuji, "Review of Advances in Gas Lift Operation," 28292, no. 1, 1994.
- [8] T. A. Everitt, "Gas-Lift Optimization in a Large , Mature GOM FIELD," *SPE*, 28466, 1994.
- [9] S. Buitrago, E. Rodriguez, and D. Espin, "Global optimization techniques in gas allocation for continuous flow gas lift systems," *SPE Gas Technol. Symp.*, 1996.
- [10] S. Handley-Schachler, C. McKie, and N. Quintero, "New Mathematical

Techniques for the Optimisation of Oil & Gas Production Systems," *SPE Eur. Pet. Conf.*, 2000.

- [11] E. Ghoniem, N. Samizo, and a Thuwainy, "Successful Application of Production Optimization Models to Sustain Field Target and to Defer Capital Investment in Offshore Khafji Field," *Spe* 93555, 2005.
- [12] F. Rashidi, E. Khamehchi, and H. Rasouli, "Oil Field Optimization Based on Gas Lift Optimization," 2010.
- [13] O. Sylvester, "Gas Lift Technique a Tool to Production Optimization," *Int. J. Oil, Gas Coal Eng.*, vol. 3, no. 3, p. 41, 2015.
- [14] M. Zain and A. Abdin, "Analysis of Gas Lift Installation Problems," *SPE 87278*, 2000.
- [15] Weatherford Company Mnual, "Gas-Lift Troubleshooting," 2007.
- [16] U. Manual and Petex, "Petroleum Experts User Manual," no. May, 2013.